

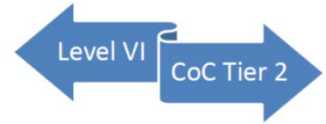

# AC-DC 5W

## 6A-052WU05B



### WALL-MOUNT (Fixed type)

#### Features:

- IEC/EN/UL/CUL 62368 & 60950
- Universal AC Input 90~264Vac
- Regulated Output With Low Ripple Noise
- 100% burn in test
- 1 year warranty
- CEC,DoE Level VI,ErP Stage 2,CoC Tier 2,GEMS
- WEEE / ROHS 2.0 / REACH 2.0
- Safety : UL/CUL,FCC

#### Dimension:

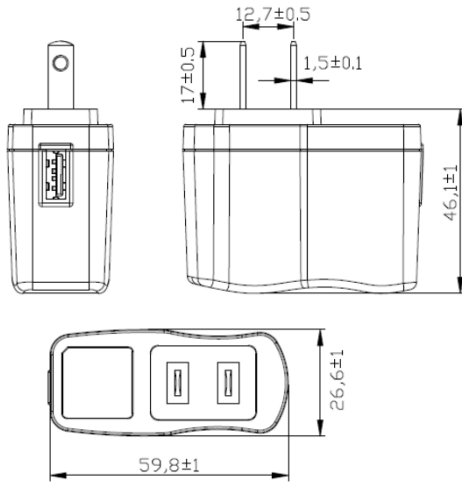

Model No.	O/P Voltage	O/P Current
6A-052WU05B	5V	1.0A

#### Specification:

Input	Voltage	AC 90V~264V Universal Full Range
	Frequency	47-63Hz
	Current	300mA
	Leakage Current	< 0.25mA
Others Protection	Start up time	< 3000mS @115VAC Full Load
	Rise time	<20mS
	Hold up time	>20mS @ 230Vac/50Hz input
	Protection	OCP/OVP/SCP
	Cooling	Natural Convection Cooling
Environment	Temperature	Operating: 0~40°C;Storage: -10~+70°C
	Humidity	Operating: 20%~85%;Storage: 10%~95%(Non Condensing)
M.T.B.F	50K Hours MIL-HDBK-217F @115VAC/ 230VAC Full Load Ambient : 25°C	
Safety Regulation	UL 62368-1, CSA C22.2 No.62368-1, IEC62368-1 , EN62368-1	
	UL 60950-1, CSA C22.2 No.60950-1, IEC60950-1 , EN60950-1	
EMC	EMI	FCC CFR 47 PART 15B , EN55032 , EN61000-3
	EMS	EN55024(EN61204-3) , EN61000-4

**英格爾科技股份有限公司**  
**ENG ELECTRIC CO.,LTD.**

台灣桃園市龜山區民生北路1段536號5樓  
5F., No. 536, Sec. 1, Minsheng N. Rd.,  
Gueishan Dist., Taoyuan City 33393,  
Taiwan (R.O.C.)



TEL:886-3-212-1122 FAX:886-3-212-1570 E-mail:eng@eng.com.tw http://www.eng.com.tw

